

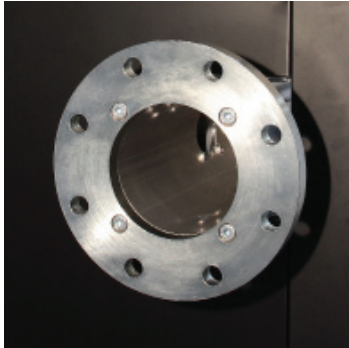

aerospace
climate control
electromechanical
filtration
fluid & gas handling
hydraulics
pneumatics
process control
sealing & shielding



The refrigeration drying solution PoleStar Smart



Compressed air contamination – A real problem for industrial production processes

Compressed air is a fundamental source of energy for the majority of industrial production processes. However air from a compressor is often too contaminated, too hot and, moreover too humid to be used as an efficient energy source without prior treatment.

During compression, atmospheric air becomes contaminated with degraded lubricating oil, dirt, wear particles and, independently of compressor type, a large amount of water. On delivery to the point of use, this abrasive sludge can destroy the very equipment it is meant to operate and, if not carefully re-moved can result in severe corrosion, increased maintenance and downtime, inevitably leading to reduced system efficiency.

Atmospheric air in industrial and urban environments can typically contain 140 million dirt particles per cubic meter of air. These particles are too small to be removed by the air inlet filter on the compressor and pass unobstructed into the compressed air system, as 80% of them are less than 2 microns in size. Water contamination causes rust and pipe-scale to form in air receivers and

Examples of typical contamination entering the compressed air system through the compressor intake

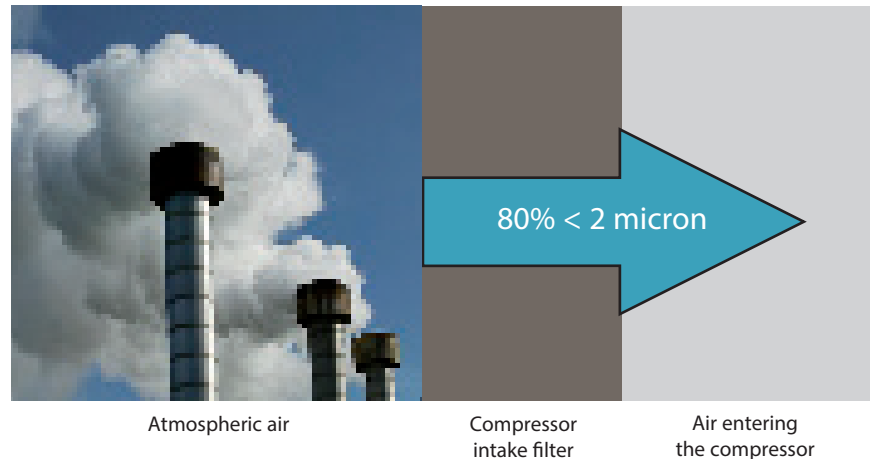

system pipe-work. This can break away and cause blockage in valves and orifices, leading to high maintenance and costly air leaks.

Atmospheric air contains oil in the form of unburned hydrocarbons which are drawn into the compressor intake. Once inside the compressed air system, these oil vapours cool and condense into liquid form.

The majority of air compressors use oil in their compression stage(s) for sealing, lubrication and cooling. The oil is in direct contact with the air as it is compressed, however, due to the efficiency of modern air/oil separation built into the compressor, only a small proportion of this lubricating oil is carried over into the compressed air system. The oil mixes with water already present and becomes acidic, losing its former lubricating characteristics.

The result is unwanted abrasive sludge which corrodes piping and can bring production processes to an expensive standstill.



Corrosion in the form of rust and pipe-scale

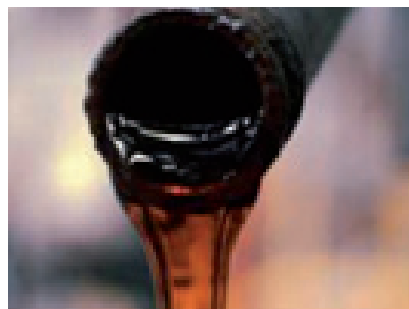

Unburned hydrocarbons and lubricating oil in liquid, aerosol and vapour form



Damaged pneumatic tooling



Unwanted abrasive sludge

Where does the water actually come from?

Atmospheric air contains a proportion of water. The relative humidity (RH) heard in the weather forecast states the amount of water vapour as a percentage that the air is able to retain before it starts to rain, compared to the maximum proportion that the air can retain at that specific temperature. For example, 60% RH at 20°C means that the air is holding 60% of the water vapour it can potentially hold at that temperature. At 100% RH, the air can no longer retain the moisture as a vapour and it is therefore manifested as dew, visible mist or fog. The temperature that causes the vapour to condense is known as the atmospheric dew-point.

The geographical humidity factors are, however, not the only significant features. The ambient conditions at specific locations within an industrial environment, such as the local humidity in a building housing a compressor room with insufficient ventilation, play an equal part. The decisive factors are, however, temperature and pressure.

The higher the temperature, the more water vapour the air can hold and vice-versa. If you expand the air, it will be able to hold a larger quantity of water vapour; the quantity it can hold will reduce if you compress it.

Example.

An air compressor takes in 8 cubic meters of atmospheric air at 20°C and 60% relative humidity. During the compression process this amount is reduced to 1 cubic meter at 7 bar pressure. The amount of water now in 1 cubic meter remains the same as that originally drawn into the compressor. The 8 cubic meters of air at 60% RH, which now take up 1 cubic meter of space exceed a relative humidity of 100%. It rains when the ambient air reaches about 100% in the normal outside world. The same is true inside the compressor receiver; as the compressor runs it continues to rain in the receiver; the greater the demand placed on the compressor, the heavier the rain, so that liquid water collects inside the compressor. The amount of water is of course relative to the humidity of the air taken in by the compressor.



Untreated compressed air does not prevent large amounts of water from collecting in air receivers and downstream piping.

A typical 30kW compressor drawing in air as mentioned above and compressing it to 7 bar pressure will generate approximately 20 litres of liquid water in an eight-hour shift. In one year this can equal as much as 4,800 litres! Whilst considering how much of a swimming pool this amount of condensate could fill, a 30kW compressor is a relatively small unit. As a plant manager, operating two 150kW compressors under the same conditions, we could expect approximately 650 litres of condensate per day. That is 156,000 litres in a year!

Water removal

As temperature dictates the amount of water which can be held in the air, the high temperatures inside a compressor maintain the water in a vapour state. That is, until the air travels through the downstream pipe-work to the point of use, cooling all the way until it finally turns into a liquid state in pneumatic equipment or in the industrial process itself. It is therefore better to remove the heat from the air as quickly as possible in a controlled manner at the exit from the compressed air system. Once condensed to a liquid state, water vapour is far easier and cheaper to remove from the compressed air system. Almost all compressed air installations are equipped with an after-cooler (air, or water-cooled; – see Parker Hiross literature on: compressed air and gas cooling solutions), which serves as the first air treatment stage at the outlet of the compressor. If the after-cooler is working correctly it can remove approximately 65% of the liquid water.

Despite the fact that the after-cooler removes large amounts of water, any



Moisture condensing on the outside of compressed air pipework (sweating)

additional decrease in compressed air temperature will result in the formation of condensate in downstream pipe-work. To deal with this physical phenomenon Parker Hiross manufactures a range of refrigeration dryers specifically designed to reduce the water content in compressed air efficiently and in an energy conscious and environmentally friendly manner, to deal with this physical phenomenon. Any additional decrease in the compressed air temperature will result in the formation of condensate in the downstream pipe-work, although the after cooler removes large quantities of water.

Removal of the remaining 35 %

The water vapour is condensed to a liquid and drained away by lowering the compressed air temperature below the ambient temperature, using refrigeration. The compressed air, now cooled to approx. 3°C, is then reheated; otherwise condensation would also arise on the cold compressed air lines running round the factory at the factory site. The air is reheated using the heat of the incoming air to the refrigeration dryer and this raises the temperature to just above the ambient temperature. The compressed air leaving the outlet of the dryer is then suitable for most industrial applications with regard to its dryness.

The Parker Hiross PoleStar refrigeration dryer stands out from the crowd and boasts innovative, easily comprehensible user benefits that save energy and avoid compressed air wastage, in association with reliability and longevity, although it features many of the traditional characteristics of commercially available dryers.

PoleStar SmartPack

At the heart of the PoleStar Smart refrigeration dryer is the SmartPack heat exchanger (patent pending). This highly-compact, all-in-one, aluminium module contains 4 treatment stages in one single unit:

1 Air-to-air heat-exchanger

The air-to-air heat exchanger functions as a pre-cooler and a re-heater. It ensures the pre-cooling of the incoming 100% saturated hot compressed air, by transferring the heat to the cold air exiting from the stainless steel demister separator on its way to the dryer outlet. This reduces the likelihood of “sweating” on external piping, which can occur on non-insulated cooled surfaces in humid conditions.

The heat exchanger supports the pre-cooling, which would otherwise have to be taken over completely by the refrigeration system, in this way, both the dimensions and the energy consumption of the refrigerating circuit as a whole are reduced.

On larger PoleStar Smart dryers (PST460 and above), the heat-exchanger block is multiplied up and installed in a modular fashion along an inlet/outlet manifold, up to a maximum of 6 modules in a row.

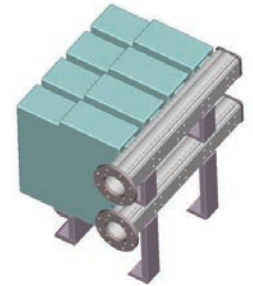
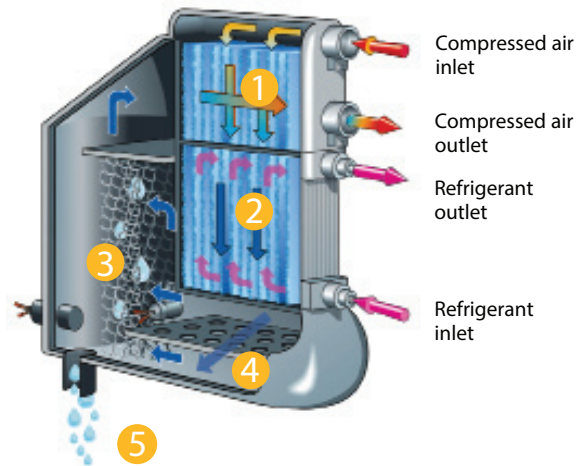

Several heat exchangers can be connected as a compact, higher capacity device, for larger dryers, such as the Polestar Smart (PST/750) shown here. Here, each unit is insulated by special heat shield insulation (on the basis of TSI poly-phenylethene), in order to achieve an even higher level of efficiency through higher heat retention.

2 Air-to-refrigerant heat exchanger (evaporator)

The air-to-refrigerant heat exchanger takes the pre-cooled air from the air-to-air heat exchanger and cools it to the required dew-point, by

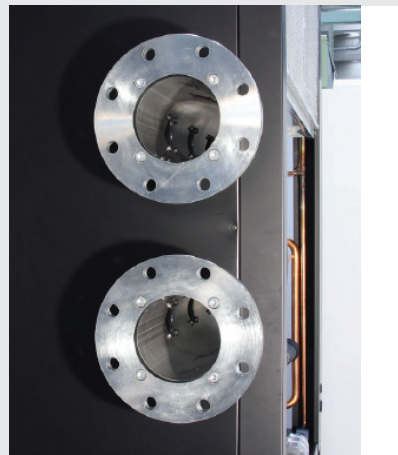

transferring heat into the evaporating refrigerant. After cooling, the air directly enters the high efficiency stainless steel demister separator where liquid water is removed, falling into the generously dimensioned drainage chamber or sump.

3 Maintenance-free demister separator

No connections between pipes are necessary, thanks to the geometric shape of the aluminium module, while unimpeded flow through the heat exchanger matrix is guaranteed, so that the air speed is low and the



heat transfer is improved. The low air speeds even permit the installation of a slow flow high performance demister separator of stainless steel above the water drainage tank.

This demister contributes to the low pressure drops within the SmartPack module, typically up to four times larger than standard separating demisters in which sufficient precipitation can frequently only be achieved with difficulty at high air flows, in comparison to normal centrifugal type demisters, while can only maintain the required precipitation performance with difficulty at low air flows.

Separation efficiency

Parker Hiross demisters achieve a constantly high level of precipitation across the whole range of flows in the dryer. The contribution of the larger demister to the need for less refrigerant in the refrigeration circuit of the dryer is an additional feature. The need for refrigerant is 15% below that of our competitors in most cases.

4 Large drainage chamber (sump)
The generously dimensioned large drainage chamber serves as a sump for the intermediate storage of fluid water until its disposal.

5 Condensate drain
PST075 to PST095 are available with a timed condensate drain or an electronic capacitive drain (zero air loss). The drainage intervals can be programmed directly by means of the control panel on the front panel of the dryer in the case of a timed drain.

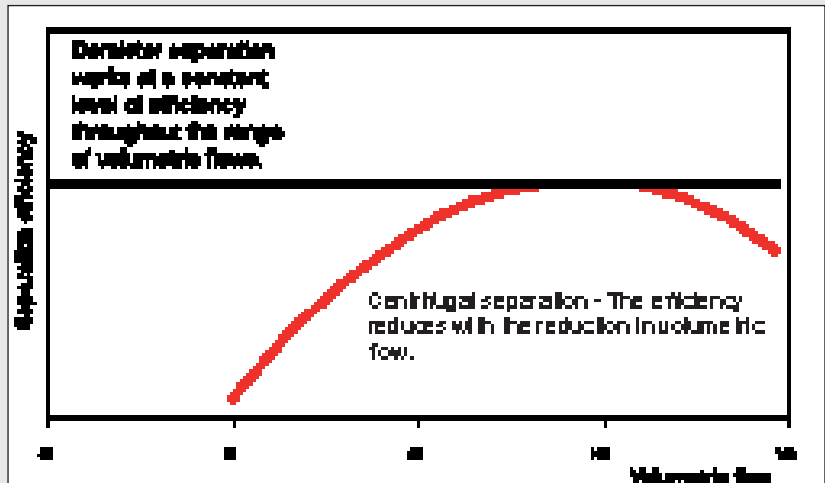

electronic capacitance drain. Refrigeration dryer, PoleStar Smart models PST075 to PST095

The zero loss drain (SmartDrainer) is synchronised to open automatically when it senses the level of condensate present in the drainage tank. The valve only opens to evacuate liquid condensate and closes before any air can escape. The self-diagnostic troubleshooting software will signal an alarm and the drain will continue to function in a pre-programmed timed mode, returning to zero loss operation when the fault has been rectified, in the unlikely event of a fault during operation



Timed condensate drain. Refrigeration dryer models PoleStar Smart PST075 to PST095.

Zero loss drain (SmartDrainer)

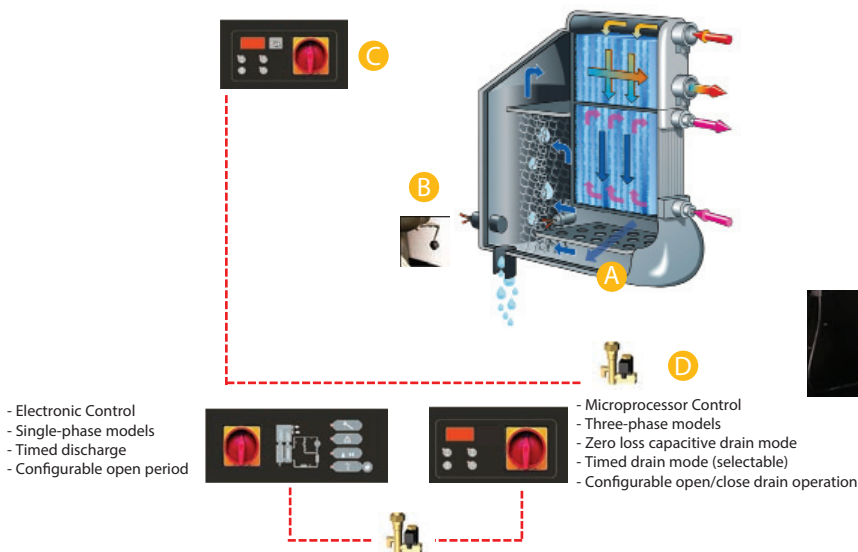

Drain valve, located in the drain niche. Easily accessible from the outside of the dryer to conduct maintenance.

PoleStar refrigeration dryers PST120 to PST1800 are supplied with an integral zero loss drain (SmartDrainer) as standard.

- A** Drainage Chamber
- B** Level sensor – located within the drainage chamber (easily accessible)
- C** Microprocessor controls on the front of the dryer.
- D** The drain valve, fitted into the drain alcove and accessible from outside the dryer.

How does the Parker Hiross

The PoleStar Smart refrigeration dryer series incorporates a “direct-expansion type” refrigeration system, thereby avoiding the higher full-load power consumption of other “indirect” configurations (i.e. thermal mass).

PoleStar Smart PST075 and PST095 dryers run continuously; a hot-gas by-pass valve controls and regulates the refrigerating circuit. The PoleStar Smart PST120 to PST1800 models have cleverly devised energy-saving features (Smart-Save, patent pending), by means of which the dryer is controlled in the on/off mode, according to the system requirements. The evaporator, the compressor, the condenser and the expansion device are the four main components of the refrigeration dryer. These components are connected to each other by means of high quality copper pipe, through which the refrigerant flows in a closed circuit

A Evaporator: (Air-to-refrigerant heat-exchanger) compressed air enters the heat-exchanger at **A** where the evaporator removes the heat and transfers this to the cold refrigerant. This heat causes the refrigerant to evaporate and change to vapour, which is returned to the compressor **B** to be compressed. On larger refrigeration dryers (PST220 and above) a large volume liquid separator **F** eliminates the risk of liquid refrigerant returning to the compressor.

B Compressor: This is a maintenance-free refrigerant compressor with high energy efficiency from a respected international manufacturer. The PoleStar Smart PST075 and PST095 models contain piston compressors, while all other models are equipped with compliant screw compressors (scroll compressors), which offer clear advantages because of their construction. Above all, low-energy requirements (up to 20% less than equivalent piston-type compressors), quiet operation and robust long-life reliability. Compliant scroll compressors require no pre heating on start-up, they are not sensitive to slugs-of liquid refrigerant and function with less refrigerant than other compressors.

C Condenser: Receives hot, high pressure vapour from the compressor and cools it down. The heat which was added to the refrigerant vapour during compression is exchanged with the cooling air / cooling water flow. (PoleStar Smart dryers are available with air-cooled condensers or watercooled condensers). Condensation occurs as the refrigerant vapour passes through the condenser, changing its state from a vapour to a high-pressure, partially cooled liquid on its way to the capillary expander **D** via a “Filter/dryer” **G**, designed to remove moisture and particulate which could be present in the refrigerant system.

D Expansion Device: the refrigerant expansion device inside PoleStar dryers is a capillary. This is a mechanical system which, in conjunction with the hot-gas by-pass valve (PST075 & PST095) or SmartSave (PST120 to PST1800) ensures a constant pressure dew-point is achieved. This capillary expander reduces the pressure of the liquid refrigerant to ensure the correct refrigerant flow rate enters the evaporator **A** thus providing for maximum heat exchange. This simple but effective capillary design with no moving parts ensures reliable results.

E Hot Gas By-Pass: Its function is to prevent freezing of the evaporator under low-flow conditions. It does this by sensing low pressure refrigerant leaving the evaporator and re-directing hot-refrigerant gas back to the compressor inlet as required. In this way the valve acts as the refrigerant circuit control device, maintaining

a constant evaporating pressure across the evaporator. This ensures optimum dew-point control under all operating conditions. PoleStar Smart dryers use a 100% modulating valve which is pressure actuated, providing an immediate reaction to variations in air flow, thus guaranteeing a stable pressure dewpoint.

On PoleStar Smart dryers incorporating SmartSave controls, the hot-gas by-pass valve is still fitted to provide additional system regulation in cases where the compressor is kept running, in order to avoid excessive compressor start/stops.

F Liquid Separator: the large volume liquid separator (PST220 and larger) eliminates the risk of liquid refrigerant returning to the compressor. Under ideal conditions the refrigerant compressor runs at constant pressure and temperature. The refrigerant existing the evaporator is normally a mixture of vapour and liquid which together flow into the liquid separator. The hot gas coming from the refrigerant compressor also flows through the liquid separator, ensuring complete vapourisation of any liquid refrigerant which be present. The warm refrigerant vapour is then suitable to continue its journey to the suction side of the compressor.

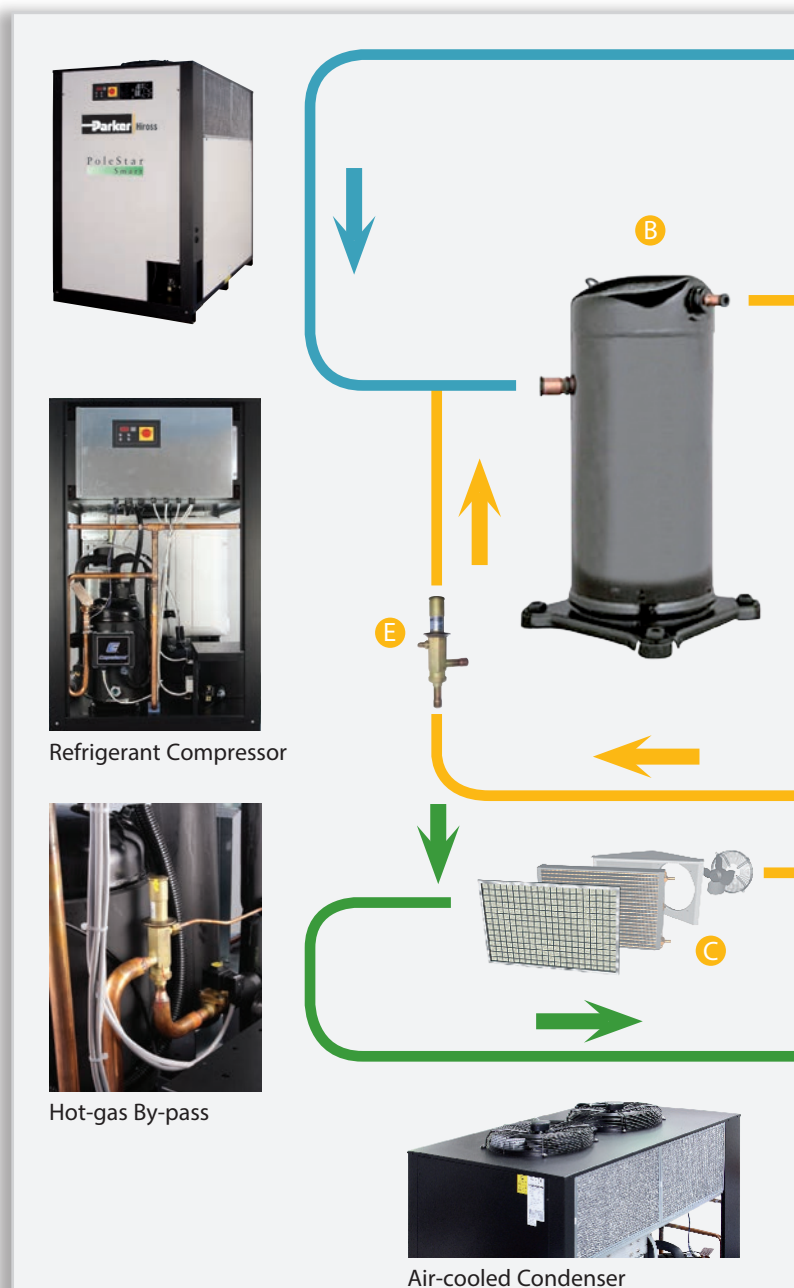

refrigeration dryer work?

Refrigeration Cycle

Low pressure refrigerant in vapour phase is compressed by the refrigerant compressor **B** and discharged to the condenser **C**. Hot refrigerant vapour enters the condenser where it is cooled by air blown across the finned tubes of the condenser, usually by a fan or alternatively from a water source (water-cooled condenser). The condenser changes the high pressure refrigerant from a high-temperature vapour to a low temperature, high pressure refrigerant liquid which flows on through a filter/dryer **C1** to remove any moisture or particulate contamination. After this stage the refrigerant liquid flows to a thermal expansion device **D**, which ensures the correct amount of liquid refrigerant is entering the evaporator. At the expansion device, high pressure liquid changes to low pressure, low temperature, saturated liquid/vapour. This saturated liquid/vapour enters the evaporator **A** at the refrigerant inlet and is changed to a low pressure, dry vapour, producing the cooling source required to cool down the incoming hot compressed air. Condensation occurs at this point and ultimately the fall out of moisture collected is drained away. The low pressure, dry vapour exits the evaporator at the refrigerant vapour outlet where it returns in the suction line to the compressor, thus completing the cycle.

The Compressed Air Cycle

Hot compressed air enters the evaporator **A** via the compressed air inlet. It passes through the air-to-air heat-exchanger **A2**, exchanging some of its heat-energy with the exiting, condensate free, dry, cold air and re-heating the same. This re-heated, air exits the evaporator at the compressed air outlet.

The incoming compressed air continues through the air to refrigerant heat-exchanger **A2**, where refrigerant cools the air down, causing condensation to occur and collect in the drainage sump for automatic evacuation.

Further condensation occurs as the air then passes through an effective demi-ster/separator designed to remove all traces of liquid condensate. At the point where the cold compressed air exits the demister/ separator it is dry and free from liquid water.

This air then exits the evaporator via the air-to-air heat-exchanger **A1**, increasing in temperature before finally exiting at the compressed air outlet.

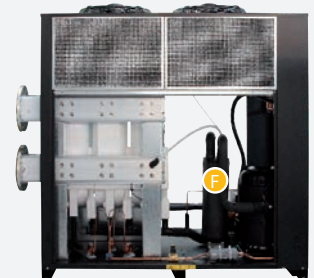
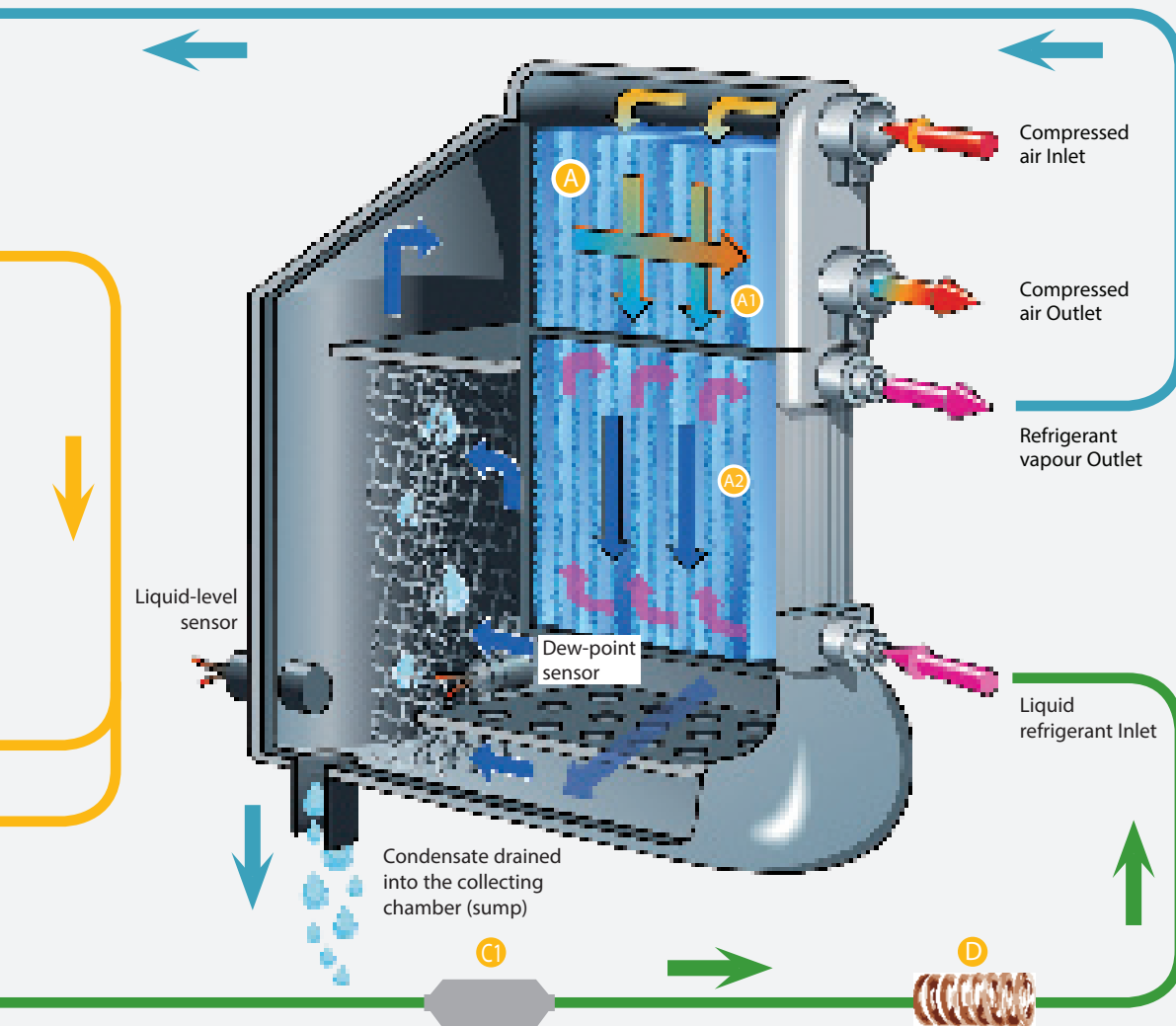

Large-volume liquid separator

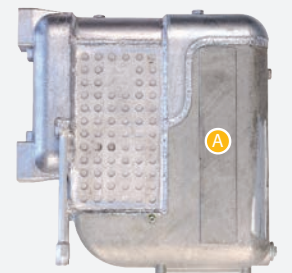

SmartPack heat exchanger



SmartDrainer - Drain valve



Filter/Dryer

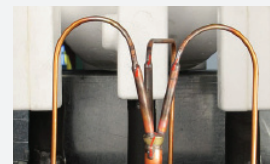

Expansion Device-Capillary



Atmospheric dew-point as demonstrated in nature

Air-cooled or Water-cooled condensers?



Air cooled condensers comprise copper pipes and aluminium fins across which air is blown by one or more axial fans. On PoleStar Smart models PST120 and larger, the condenser is protected by a wire-mesh pre-filter which significantly reduces dirt accumulation on the

condenser and contributes to energy saving. On all PST models from PST220 and larger, the condenser section is completely independent from the rest of the dryer, this allows for maintenance to be undertaken whilst the dryer remains in operation.

Water-cooled condensers are available on all PoleStar models from PST220 to PST1800. The plate-heat-exchanger design is used where an air-cooled refrigeration dryer would not work reliably. For instance, where the dryer is to be installed in an enclosed, warm area and/or where a cold water source is readily available. All water-cooled refrigeration dryers are supplied with presso-static valves to modulate the incoming water flow in accordance with the incoming water temperature and consequential condensing pressure.

Plate-heat-exchanger
(water-cooled-condenser)



NOTE
Water cooled condensers suitable for sea-water are available as an option.

Pressure dew-point – measuring the level of “dryness”

Pressure has an effect on the level of water vapour contained in compressed air. As a result, the atmospheric dew-point cannot be used to measure the dryness of compressed air. In this case we refer to pressure dew-point. This is the temperature at which water

vapour contained in compressed air at a particular pressure will condense to form liquid water. Most refrigeration dryers provide a pressure dew-point of between 3 and 7 °C (ISO 8573-1). Water will start to condensate at temperatures just below these figures.

Condensation should not arise, even on the hottest days, unless compressed air lines pass through, or finish in, areas where the ambient temperature is lower than the pressure dew-point set in the dryer.

Refrigeration Dryer Sizing

Dryers are initially sized around a known airflow, and then correction factors are applied for the known environmental conditions. A minimum of four things have to be taken into account:

- 1 The flow passing through the dryer or the compressor type
- 2 The compressed air temperature entering the dryer
- 3 The ambient air temperature
- 4 The operating pressure

The refrigeration dryer should be conservatively sized to cope with the highest anticipated flow at the lowest expected pressure and should be capable of operating without overload on even the hottest days.

Typical Temperatures in a „normal compressed air system”

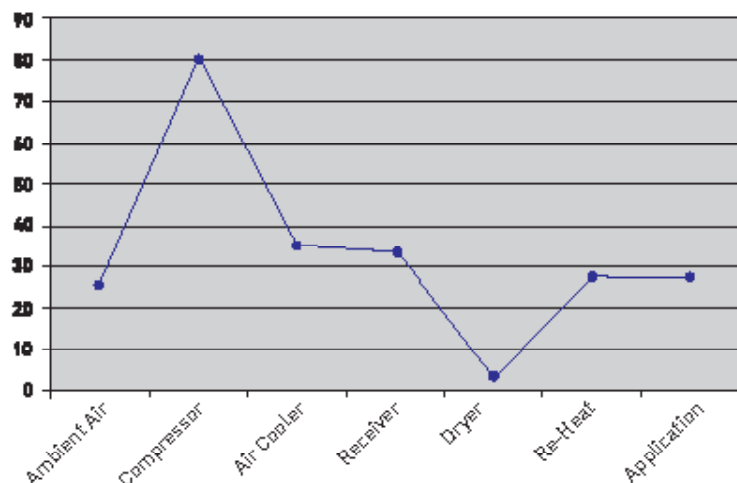

Parker Hiross PoleStar Smart Energy Saving Dryers (PST120 and above)

A refrigeration dryer is typically selected to achieve its design performance at the users most extreme working conditions (i.e. a warm summers day with a compressor operating at maximum load). These maximum load conditions are very rarely experienced under every day operating conditions – First and foremost the compressor load will vary significantly during the working day, thereby reducing the load on the refrigeration dryer itself. Furthermore, average operating tempera-



Thermal Shield Insulation enclosing individual and multiple heat-exchangers provides high-thermal retention.

tures are usually well below the maximum for which the system has been designed. Seasonal variations and ambient operating temperatures affected by compressor room ventilation can all add a further reduction to the load on the dryer. The result is that the refrigeration dryer could, if it were capable of adapting its working cycle to actual conditions, save significant amounts of energy.

Parker Hiross PoleStar dryers do just that, continually and precisely modulating their mode of operation to meet actual operating requirements, resulting in accurate dew-point monitoring with aligned power consumption.

The cycling, energy-saving feature of the PoleStar refrigeration dryer (“PoleStar Smart”) effectively and precisely controls and monitors the start/stop operation of the refrigerant compressor during periods of alternating demand. To enable this to happen, the dryer runs for a period of time without active cooling provided by the compressor, utilising only the stored “cold-reserves” contained within the aluminium SmartPack heat-exchanger. By fully integrating the functions of evaporation, condensation and effective drainage

in one block of aluminium with large overall surface area, we are able to profit from the thermal attributes of this material, utilising the stored energy to maintain dewpoint at zero cost. The addition of efficient insulation material enclosing the heat-exchanger effectively prolongs the period of stop/start compressor control.

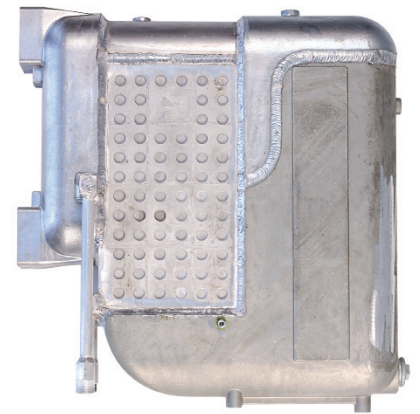

Polestar Smartpack, all-in-one aluminium heat-exchanger

Protecting the heart of PoleStar Smart

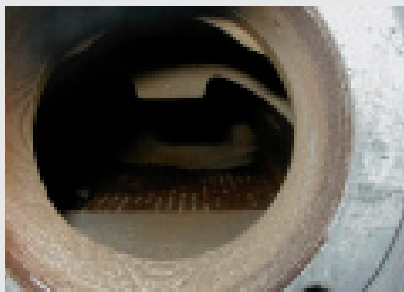

Protecting the heart of PoleStar Smart. Damage and corrosion to the heat-exchanger, reducing efficiency and length of service due to the omission of a pre-filter before the refrigeration dryer.

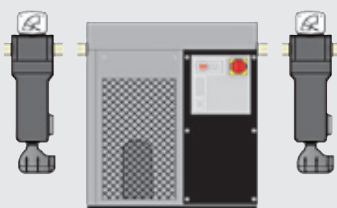

The provision of a pre-filter before a refrigeration dryer is not a luxury but an essential component in any compressed air installation. The intricate channels and chambers within the construction of the heat-exchanger can only achieve their maximum thermodynamic performance at minimum cost, where protection against particles and oil is provided (cost of pressure loss: the cost of electrical energy rises by 1% for each increase in pressure drop of 140 mbar). Where filtration is installed, the costly premature replacement of heat exchangers becomes a thing of the past.

PoleStar Smart

The Parker Hiross refrigeration dryer provides 'best in class performance' with regard to the overall pressure drop across the range of throughputs, in addition to PoleStar Smart energy features enabled by the unique all-in-one SmartPack heat exchanger. Large air channels leading to low air speeds, coupled with the absence of interconnecting pipework, contribute to the unrivalled low cost of ownership.

Maximum dew-point control is achieved by:

- large air channels leading to low air flow velocity
- an oversized demister separator providing optimum condensate separation, even at partial air flows
- a dew-point sensor positioned in the air flow, to ensure optimum control.

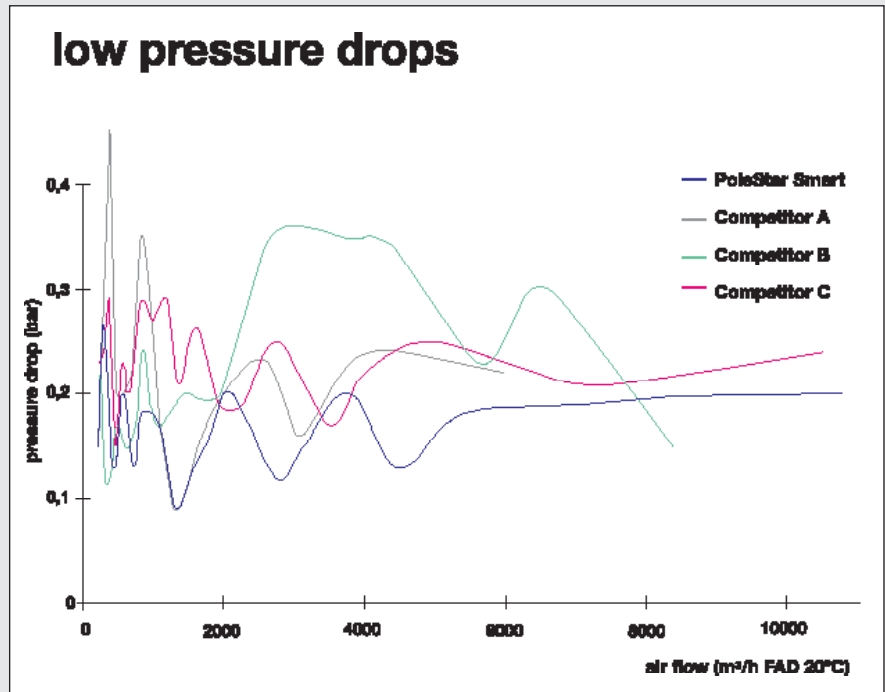

(Note: every 140mbar of pressure drop adds approx. 1% to the cost of electrical power required by the compressor)

PoleStar Smart is supplied exclusively with compliant scroll compressors (from PST120 upwards) offering energy savings of up to 20%, in comparison to other systems. These compressors are very robust; they are resistant to refrigerant backflow and have 50% fewer moving parts than similar technologies.

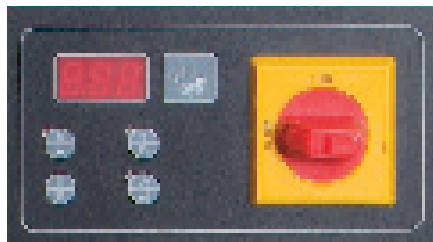

An additional standard feature on models from PST120 upwards is SmartControl. This multi-functional display provides an accurate digital dewpoint reading and visual indication of the coded alarm monitoring of the dryer.

SmartControl also controls SmartSave (patent pending); the user is informed that the dryer is running in the energy-saving mode. At the same time, a display shows the respective energy saving achieved.

Maintenance intervals are periodically displayed whilst the provision of a status report (indicating the last eight events) and hours-run meter simplify service.

Standard voltage-free contacts, MOD-BUS compatible supervisor (no gateway required) and an optional RS485 serial card connection allow remote monitoring of the dryer.

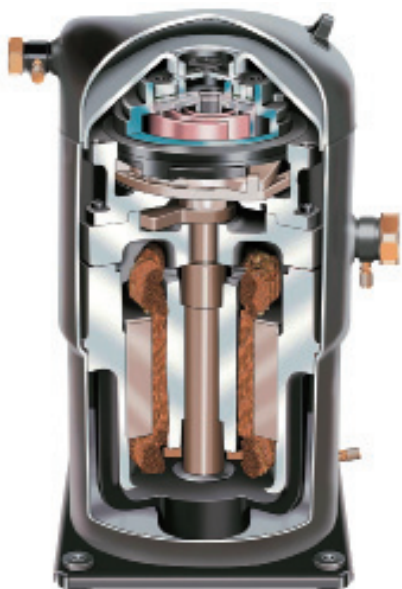

Refrigeration Dryers PoleStar Smart

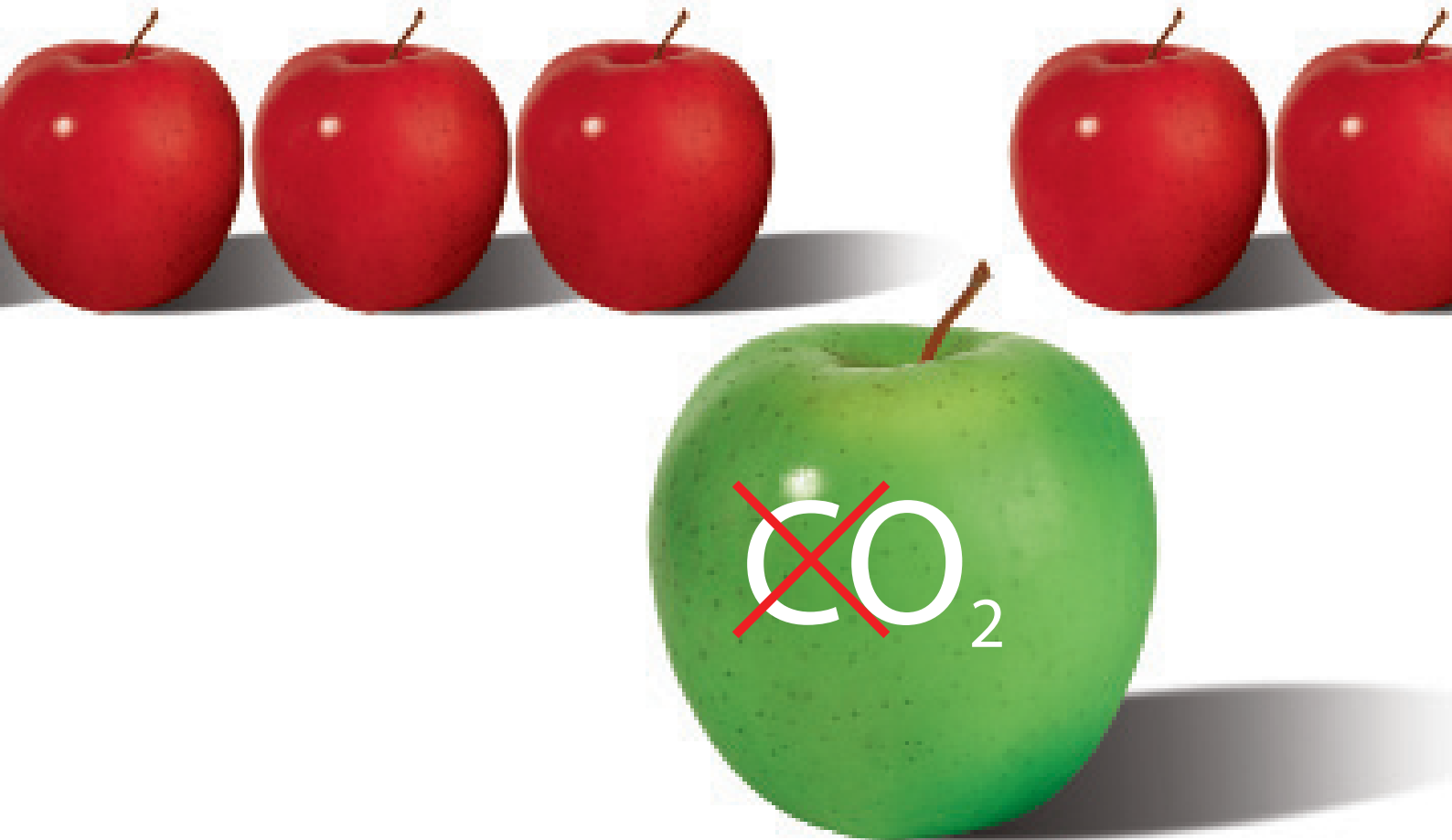

Standing out from the crowd!



Philosophy





Parker Hiross has been a long-standing, respected supplier of refrigeration technology to industry since 1964. Our philosophy to “stand out from the crowd” ensures products that also provide the user with clean, high quality compressed air, but with energy savings second to none, low lifetime costs and reduced CO₂ emissions.





Protecting the environment and your investment





Product Features:

- Suitable for all compressed air applications
- Suitable for all compressor types, including variable flow
- The most energy efficient compressed air refrigeration dryer
- Low pressure drops for lower operational costs
- Cost of ownership reduced
- Significantly contributes to the indirect reduction of CO₂ released into the environment.

A comparison between the Parker Hiross dryer and other dryers (cycling and thermal mass) offers the following advantages to the user, taking the three most popular dryers into account:

Dryer Model 12 m ³ /min Medium/High load profile (*)	Energy-saving features promoted by other dryer manufacturers			Parker Hiross SmartSave Energy-saving Technology
	"Cycle Saving" technology	Thermal Mass Technology	Hot-Gas By-pass Technology	
Annual energy consumption kWh	3,318	4,884	8,994	2,533
Energy costs/year in €	332	488	899	253
Annual CO ₂ produced (kg)	2,658	3,925	7,231	2,036
				
	24%	48%	72%	← Lower CO ₂ emissions burden and annual energy-saving with Parker Hiross Technology (expressed in % compared to other solutions)

Dryer Model 18 m ³ /min Medium/High load profile (*)	Energy-saving features promoted by other dryer manufacturers			Parker Hiross SmartSave Energy-saving Technology
	"Cycle Saving" technology	Thermal Mass Technology	Hot-Gas By-pass Technology	
Annual energy consumption kWh	6,014	6,266	21,877	3,272
Energy costs/year in €	601	626	2,188	327
Annual CO ₂ produced (kg)	4,836	5,030	17,588	2,631
				
	46%	48%	85%	← Lower CO ₂ emissions burden and annual energy-saving with Parker Hiross Technology (expressed in % compared to other solutions)

Dryer Model 46 m ³ /min Medium/High load profile (*)	Energy-saving features promoted by other dryer manufacturers			Parker Hiross SmartSave Energy-saving Technology
	"Cycle Saving" technology	Variable Speed Technology	Hot-Gas By-pass Technology	
Annual energy consumption kWh	10,576	11,888	30,170	7,037
Energy costs/year in €	1,058	1,189	3,017	704
Annual CO ₂ produced (kg)	8,503	9,558	24,257	5,658
				
	33%	41%	77%	← Lower CO ₂ emissions burden and annual energy-saving with Parker Hiross Technology (expressed in % compared to other solutions)

*) Calculation based on the following assumptions:

1. One production shift – 2000 hours (5 working days/week/yr.)
2. Periods of "off-load" during the working day – 4000 hours – are calculated at zero-energy usage.
The dryer is switched off at weekends and public holidays.
3. Annual energy costs/year 10€/cent per kWh.
4. Medium/High load profile – 60% to 80% average load on the dryer is for 80% of the time over the mid-range, and 20% below.

Technical data PoleStar Smart®

Model	Air Flow		Nominal abs. power kW	Air connections in/out	Dimensions (mm)			Weight kg	Pre filter	Post filter
	m³/min	m³/h			A Width	B Height	C Depth			
PST075	7,5	450	0,90	1 ½"	703	945	562	83	HFN122Q	HFN122P
PST095	9,5	570	1,38	1 ½"	703	945	562	83	HFN122Q	HFN122P
PST120	12	720	1,13	2"	706	1.064	1.046	145	HFN122Q	HFN122P
PST140	14	840	1,14	2"	706	1.064	1.046	145	HFN175Q	HFN175P
PST180	18	1.080	1,46	2"	706	1.064	1.046	155	HFN205Q	HFN205P
PST220	22	1.320	1,68	2 ½"	806	1.316	1.166	230	HFN300Q	HFN300P
PST260	26	1.560	2,19	2 ½"	806	1.316	1.166	240	HFN300Q	HFN300P
PST300	30	1.800	2,41	2 ½"	806	1.316	1.166	245	HFN370Q	HFN370P
PST350	35	2.100	3,06	2 ½"	806	1.316	1.166	250	HFN370Q	HFN370P
PST460	46	2.760	3,14	DN100	1.007	1.690	1.097	470	NFF610Q	NFF610P
PST520	52	3.120	3,54	DN100	1.007	1.722	1.097	490	NFF610Q	NFF610P
PST630	63	3.780	4,64	DN100	1.007	1.722	1.657	580	NFF750Q	NFF750P
PST750	75	4.500	5,73	DN150	1.007	1.722	1.657	670	NFF1000Q	NFF1000P
PST900	90	5.400	7,63	DN150	1.007	1.722	1.657	690	NFF1000Q	NFF1000P
PST1200	120	7.200	8,92	DN150	1.007	2.048	1.657	830	NFF1510Q	NFF1510P
PST1500	150	9.000	12,35	DN200	1.007	2.208	2.257	1.100	NFF1510Q	NFF1510P
PST1800	180	10.800	15,96	DN200	1.007	2.208	2.257	1.190	NFF2000Q	NFF2000P
PST2400*	240	14.400	18	DN200	2.007	2.736	4.148	2.335	included	on request
PST3000*	300	18.000	25	DN250	3.279	2.834	2.753	2.930	included	on request
PST3600*	360	21.600	32	DN250	3.279	2.834	2.753	3.150	included	on request

Performances refer to air-cooled models with air suction of FAD 20 °C/1 bar A, and the following operating conditions: air suction 25 °C/60 % RH, 7 barg working pressure, pressure dew-point in accordance with DIN ISO 8573-1, 25 °C cooling air temperature, 35 °C compressed air inlet temperature. All indicated data refers to DIN ISO 7183. All models supplied with refrigerant R407C and for operation up to 14 barg. 50Hz models PST075-095 supplied with 230V/1ph/50Hz power supply, models PST120-1800 with 400V/3ph/50Hz. Water-cooled versions available from model PST220. PST075-350 models with BSPP-F connections. The 60Hz version of the PoleStar Smart® models is available from 7m³/min air flow.

*Twin models supplied with master controller, electronic integral drains, manifolds, manual valves and pre-filter with automatic drain.

Air flow correction factors for different working conditions

A) working pressure correction factors	bar	3	4	5	6	7	8	9	10	11	12	13	14
		0,74	0,83	0,90	0,96	1	1,04	1,07	1,08	1,11	1,12	1,14	1,15
B) air inlet temperature correction factors	°C	30	35	40	45	50	55	60	65				
		1,23	1	0,84	0,70	0,59	0,50	0,45	0,40				
C) ambient temperature correction factors	°C	20	25	30	35	40	45	50					
		1,06	1	0,95	0,90	0,83	0,77	0,72					
D) pressure dew point correction factors	°C	3	5	7	10								
		1	1,10	1,21	1,40								

Multiply the air flow by the above correction factors (i.e. air flow x A x B x C x D), to obtain the required air flow. PoleStar Smart dryers can be operated at ambient temperatures up to 50°C and air inlet temperatures up to 65°C. The above correction values are approximate; always refer to the software selection programme or contact your Parker Hiross partner for a precise selection.

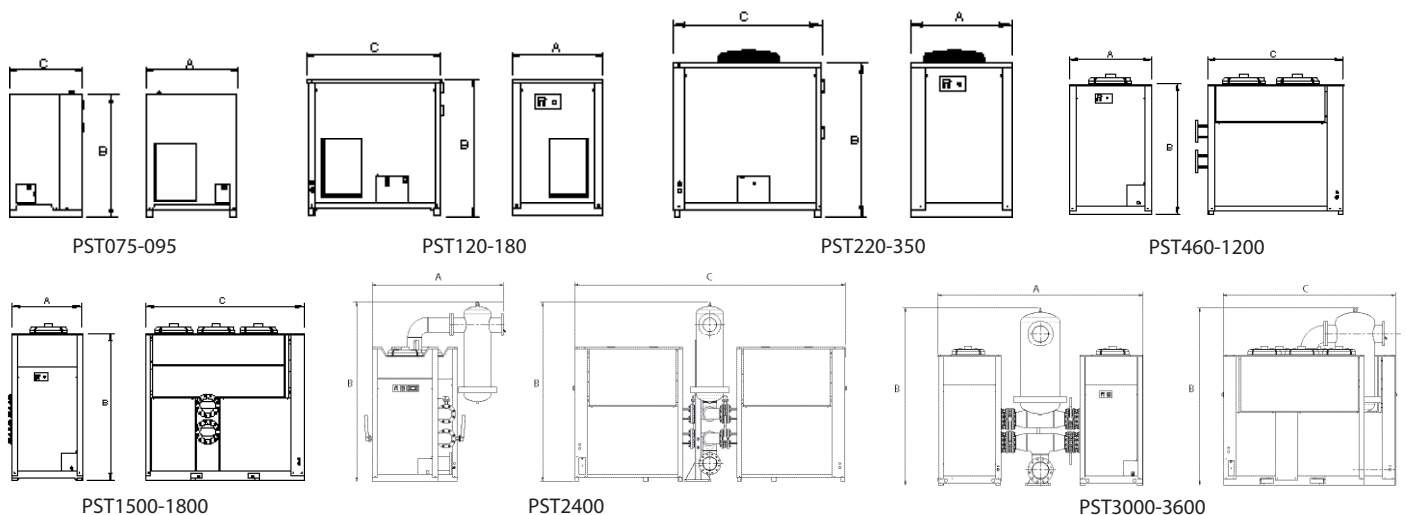

Technical data PoleStar Smart HP®

Model	Air Flow		Nominal abs. power kW	Air connections in/out	Dimensions (mm)			Weight kg	Pre filter	Post filter
	m ³ /min	m ³ /h			A Width	B Height	C Depth			
PSH030	3	180	0,53	1 1/4"	703	945	562	83	HFP031Q	HFP031P
PSH045	4,5	270	0,55	1 1/4"	703	945	562	83	HFP050Q	HFP050P
PSH065	6,5	390	1,33	1 1/4"	703	945	562	85	HFP068Q	HFP068P
PSH090	9	540	1,37	1 1/4"	703	945	562	85	HFP093Q	HFP093P
PSH120	12	720	1,41	1 1/4"	706	1.064	1.046	152	HFP140Q	HFP140P
PSH160	16	960	1,44	1 1/4"	706	1.064	1.046	152	HFP140Q	HFP140P
PSH200	20	1200	1,47	1 1/4"	706	1.064	1.046	152	HFP220Q	HFP220P
PSH230	23	1380	1,52	1 1/4"	706	1.064	1.046	152	HFP220Q	HFP220P
PSH290	29	1740	2,89	2 1/2" ANSI	1.007	1.690	1.097	356	HFP420Q	HFP420P
PSH380	38	2280	3,18	2 1/2" ANSI	1.007	1.690	1.097	356	HFP420Q	HFP420P
PSH460	46	2760	3,44	2 1/2" ANSI	1.007	1.690	1.097	356	HFP420Q	HFP420P
PSH630	63	3.780	4,12	2 1/2" ANSI	1.007	1.690	1.657	455	HFP640Q	HFP640P
PSH800	80	4.800	6,6	2 1/2" ANSI	1.007	1.723	1.657	610	HFP780Q	HFP780P
PSH1000	100	6.000	6,9	2 1/2" ANSI	1.007	1.723	1.657	610	2 x HFP640Q (*)	2 x HFP640P (*)
PSH1200	120	7.200	7,3	2 1/2" ANSI	1.007	1.723	1.657	610	2 x HFP640Q (*)	2 x HFP640P (*)

(*) to be installed in parallel.

Performances refer to air-cooled model with air suction of FAD 20 °C / 1 bar A, and the following operating conditions: air suction 25 °C / 60 % RH, 40 barg working pressure, 25 °C cooling air temperature, 35 °C compressed air inlet temperature and pressure dewpoint in accordance with DIN ISO8573-1. All indicated data refers to DIN ISO 7183. All models supplied with R407C. All models are supplied with timed integrated drains and designed for operation up to 50 barg. Models PSH030-230 supplied with BSPT-F air connections. Flanged models supplied with stainless steel ANSI flanges; counterflanges and DIN flanges available on request. Please contact your Parker Hiross partner for different models and versions.

Air flow correction factors for different working conditions

A) working pressure correction factors	bar	15	20	25	30	35	40	45	50
		0,85	0,91	0,94	0,97	0,99	1	1,01	1,01
B) air inlet temperature correction factors	°C	30	35	40	45	50	55	60	65
		1,18	1	0,87	0,77	0,69	0,62	0,56	0,50
C) ambient temperature correction factors	°C	20	25	30	35	40	45	50	
		1,02	1	0,98	0,95	0,93	0,90	0,86	
D) pressure dew point correction factors	°C	3		5		7		10	
		1		1,16		1,25		1,40	

Multiply the air flow by the above correction factors (i.e. air flow x A x B x C x D), to obtain the required air flow. PoleStar Smart dryers can be operated at ambient temperatures up to 50°C and air inlet temperatures up to 65°C. The above correction values are approximate; always refer to the software selection programme or contact your Parker Hiross partner for a precise selection.

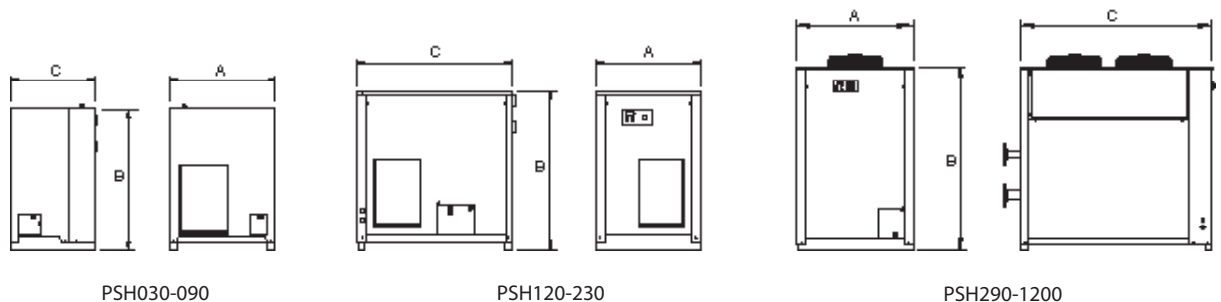



EMEA Product Information Centre
Free phone: 00 800 27 27 5374
(from AT, BE, CH, CZ, DE, DK, EE, ES, FI, FR, IE, IL,
IS, IT, LU, MT, NL, NO, PL, PT, RU, SE, SK, UK, ZA)

US Product Information Centre
Toll-free number: 1-800-27 27 537
www.parker.com



FILCO, spol. s r.o.
Dvorská 464/103
CZ-503 11 Hradec Králové
Tel: +420 495 436 233
info@filco.cz
www.filco.cz

Your local authorized Parker distributor