

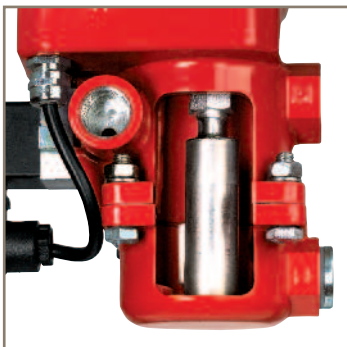

aerospace
climate control
electromechanical
filtration
fluid & gas handling
hydraulics
pneumatics
process control
sealing & shielding



Electronic Condensate Drains

ecodrain ED series for compressed air
and industrial gases



Electronic Condensate Drains

ecodrain ED3000 series

Features and Advantages

Electronic condensate drains of the ecodrain ED3000 series feature:

- Non-wearing magnetic-core level control for optimised and lossfree discharge of condensate.
- Integrated dirt screen between level measurement and drain valve to protect the diaphragm valve with alarm monitoring.
- Diaphragm valve with large cross-section and condensate pilot control for extended service life.
- Potential-free alarm contact (except ED3002, ED3004).



Non-wearing magnetic-core level control

The magnetic-core level control employs fixed switching points to operate the valve. The magnetic core signal transmitter position is detected by non-contact magnetic sensors:

- independently of the condensate type (water/oil).
- independently of the working pressure.

The collection tank integrated in the condensate drain is always used at optimum efficiency.

This results in a minimised number of switching cycles and thus, in a maximum service life of the drain valve. No calibration required!

Integrated dirt screen

The dirt screen which is integrated between the level control and the drain valve:

- retains any contaminants that could damage the diaphragm valve.
- triggers an alarm, also if the screen is clogged by dirt.
- allows the drain to be cleaned easily and rapidly.

Therefore, it considerably increases the operating safety of the condensate drain. Since the condensate is pressed through the screen at working pressure, a cleaning will normally not be necessary between maintenance intervals.

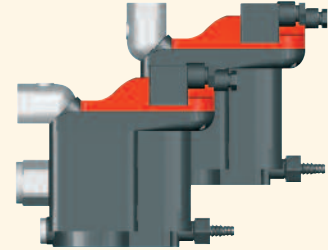

Revolving condensate inlet with additional balance option:

- Condensate line can be connected from top or side.
- Simply rotate the condensate inlet and connect.

The connection for an additional vent line integrated in the top condensate inlet provides completely new connecting options so that condensate can no longer back up into the feed lines.

Easy installation and servicing

- ED3002 can be removed together with the filter bowl remaining on.
- The drain can be removed quickly and easily from its place of installation.
- Servicing can be carried out in a convenient location.
- Cables to install new units can be ready-made.

Therefore, the ecodrain ED3000 series is a real contribution to preventive health care and avoids pain in the knees and back.

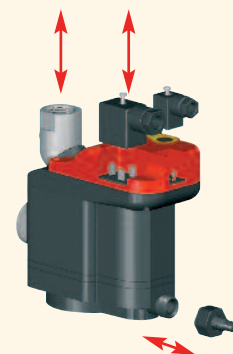

Specifications

Range of application: Compressed air up to 16 bar – normal condensates

Model/Order no.	Compressor aftercooler	Refrigeration dryer	Capacity ^{*1}		Max.working pressure	Temperature range	Connections
			Filter ^{*2}				
ED3002-G230	---	---	720 m ³ /h		16 bar	1 – 60 °C	G 3/8
ED3004-G230	240 m ³ /h	480 m ³ /h	2.400 m ³ /h		16 bar	1 – 60 °C	1 x G 1/2, G 1/8
ED3007-G230	420 m ³ /h	840 m ³ /h	4,200 m ³ /h		16 bar	1 – 60 °C	2 x G 1/2, G 1/8
ED3030-G230	1,800 m ³ /h	3,600 m ³ /h	18,000 m ³ /h		16 bar	1 – 60 °C	2 x G 1/2, G 1/8
ED3100-G230	6,000 m ³ /h	12,000 m ³ /h	60,000 m ³ /h		16 bar	1 – 60 °C	2 x G 1/2, G 1/8

^{*1} referred to 1 bar(a) and 20°C at 7 bar working pressure, suction air compressor 25°C at 60% RH, air discharge temperature aftercooler 35°C, pressure dew-point refrigeration dryer 3°C.

^{*2} Condensate from aftercooler or refrigeration dryer already drained upstream – only for residual oil content or small quantities of condensate

Standard version with BSP thread (G) for 230V/50 - 60Hz supply voltage (230). Alternatively, versions with NPT thread (N) or 115V/50 - 60Hz (115) or 24V/50 - 60Hz (024) are available. 24V DC on request.

Notes on power supply with instable voltage:

We recommend that you use 24VDC units with appropriate power supplies in operating environments with heavily fluctuating mains voltages or high frequency interference (short voltage peaks or voltage drops). This will ensure a reliable long-term operation even where unfavourable power conditions prevail.

Accessories and servicing items:



Plugs (for cable preparation)

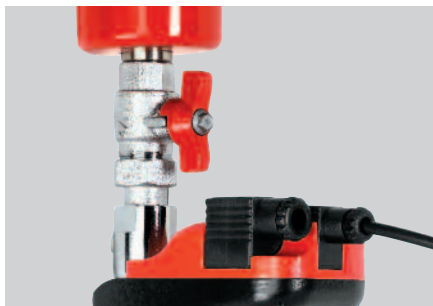

Installation kits



Service kits

Dimensional drawings and weights:

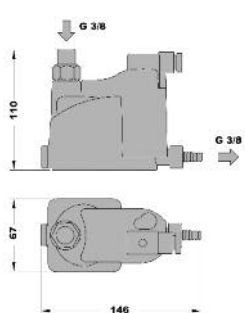

ED3002
0,5 kg

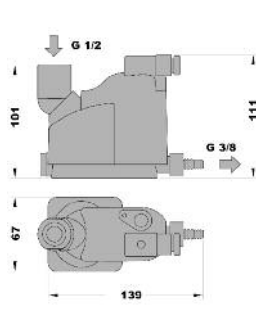

ED3004
0,6 kg

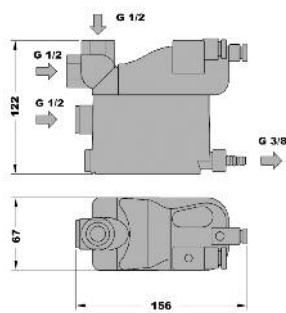

ED3007
1,0 kg

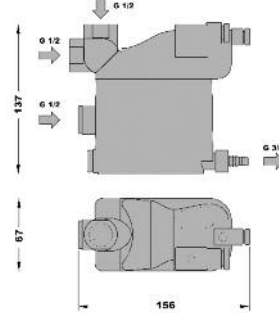

ED3030
1,1 kg

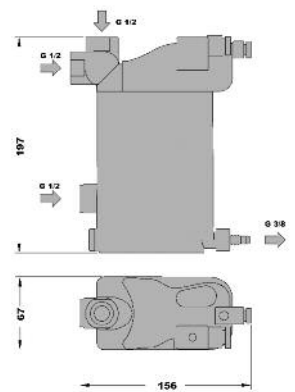

ED3100
1,5 kg

Electronic Condensate Drains

ecodrain ED2000 series

Features and Advantages

Electronic condensate drains of the ecodrain ED2000 series feature:

- Non-wearing magnetic-core level control for optimised and loss-free discharge of condensate.
- Robust and high-pressure resistant metal design. Made of compacted and sealed aluminium. Additional protection with an inside and outside powder coating.
- Diaphragm valve with large cross-section for extended service life
- Potential-free alarm contact.



Robust metal design

All housing components that come into contact with the condensate are made of compacted and sealed metal (Maldaner process) and ensure:

- almost indestructible robustness of the product.
- extreme resistance to aggressive media (up to pH 3).

Therefore, the ecodrain ED2000 series is suitable not only for applications with up to 50 bar but also for use with certain industrial gases. A special CO₂ version is available for gaseous carbon dioxide at pressures of up to 25 bar.

Heater

A frost proof option is available with:

- Thermostat-controlled heater.
- Insulating shells.

The ecodrain ED2000 series complies with protection class IP65 and is therefore suitable for outdoor installation and, in combination with the optional heater, even for installation in outdoor environments where there is a possibility of frost.

Non-wearing magnetic-core level control

The magnetic-core level control employs fixed switching points to operate the valve. The magnetic core signal transmitter position is detected by non-contact magnetic sensors:

- independently of the condensate type (water/oil).
- independently of the working pressure.

The collection tank integrated in the condensate drain is always used at optimum efficiency.

This results in a minimised number of switching cycles and thus, in a maximum service life of the drain valve. No calibration required!



Specifications

Range of application: Compressed air and (certain) industrial gases up to 50 bar - normal and problematic condensates

Model/Order no.	Capacity ^{*1}			Max.working pressure	Temperature range	Connections
	Compressor aftercooler	Refrigeration dryer	Filter ^{*2}			
ED2010-G230	1,290 m ³ /h	2,580 m ³ /h	12,900 m ³ /h	16 bar	1 - 60 °C	2 x G 1/2
ED2020-G230	6,000 m ³ /h	12,000 m ³ /h	60,000 m ³ /h	16 bar	1 - 60 °C	3 x G 3/4
ED2060-G230	66,000 m ³ /h	132,000 m ³ /h	660,000 m ³ /h	16 bar	1 - 60 °C	3 x G 3/4
ED2010/25-G230	1,290 m ³ /h	2,580 m ³ /h	12,900 m ³ /h	25 bar	1 - 60 °C	2 x G 1/2
ED2020/25-G230	6,000 m ³ /h	12,000 m ³ /h	60,000 m ³ /h	25 bar	1 - 60 °C	3 x G 3/4
ED2060/25-G230	66,000 m ³ /h	132,000 m ³ /h	660,000 m ³ /h	25 bar	1 - 60 °C	3 x G 3/4
ED2010/40-G230	1,290 m ³ /h	2,580 m ³ /h	12,900 m ³ /h	40 bar	1 - 60 °C	2 x G 1/2
ED2020/40-G230	6,000 m ³ /h	12,000 m ³ /h	60,000 m ³ /h	40 bar	1 - 60 °C	3 x G 3/4
ED2060/40-G230	66,000 m ³ /h	132,000 m ³ /h	660,000 m ³ /h	40 bar	1 - 60 °C	3 x G 3/4
ED2010/50-G230	1,290 m ³ /h	2,580 m ³ /h	12,900 m ³ /h	50 bar	1 - 60 °C	2 x G 1/2
ED2010/25-G230/CO ₂	1,290 m ³ /h	2,580 m ³ /h	12,900 m ³ /h	25 bar	1 - 60 °C	2 x G 1/2
ED2020/25-G230/CO ₂	6,000 m ³ /h	12,000 m ³ /h	60,000 m ³ /h	25 bar	1 - 60 °C	3 x G 3/4
ED2060/25-G230/CO ₂	66,000 m ³ /h	132,000 m ³ /h	660,000 m ³ /h	25 bar	1 - 60 °C	3 x G 3/4

^{*1} referred to 1 bar(a) and 20°C at 7 bar working pressure, suction air compressor 25°C at 60% RH, air discharge temperature aftercooler 35°C, pressure dew-point refrigeration dryer 3°C

^{*2} Condensate from aftercooler or refrigeration dryer already drained upstream - only for residual oil content or small quantities of condensate

Standard version with BSP thread (G) for 230V/50 - 60Hz supply voltage (230).

Alternatively, versions with NPT thread (N) or 115V/50 - 60Hz (115) or 24V/50 - 60Hz (024) are available.

24V DC on request

Accessories and servicing items:



Heater



Installation kits



Service kits

Dimensional drawings and weights:

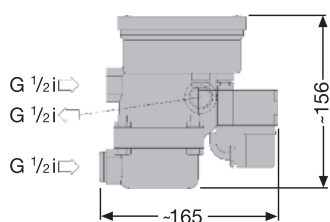

ED2010

2 kg

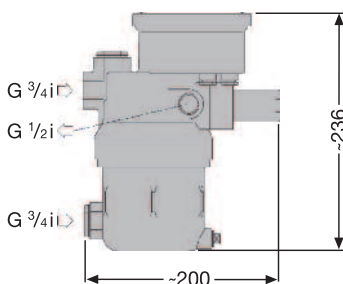

ED2020

2,9 kg

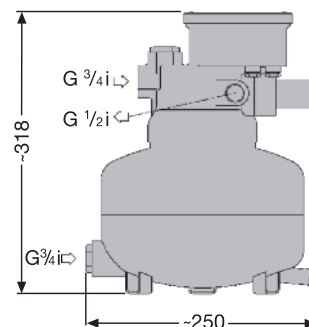

ED2060

9,4 kg

Why Electronic Condensate Drains?

Electronic condensate drains with level control ensure lossfree condensate discharge

The condensate accumulates in the collection tank (1) integrated in the electronic condensate drain. An electronic level controller (2) continuously monitors the level. When the maximum level is reached, the electric drain valve (3), which is also integrated in the condensate drain, will open and thus drain the condensate from the compressed air system. When a minimum level is reached, the valve closes in time before compressed air can escape. This prevents the loss of compressed air.

Electronic condensate drains with diaphragm valves discharge condensate reliably.

Condensate drainage via a diaphragm valve with large cross-section (4) ensures that contaminants are flushed out and thus ensures a long service

life and fault-free operation of the valve. At the same time, condensate is prevented from forming an emulsion that would need expensive condensate treatment.

Electronic condensate drains with alarm contact monitor condensate drainage

If a fault has occurred, i.e. if the condensate cannot be discharged, the electronic control board (5) of the condensate drain generates an alarm signal. This allows timely detection and avoidance of damage caused by condensate to the downstream compressed air system or to the production, which may sometimes lead to immense costs.

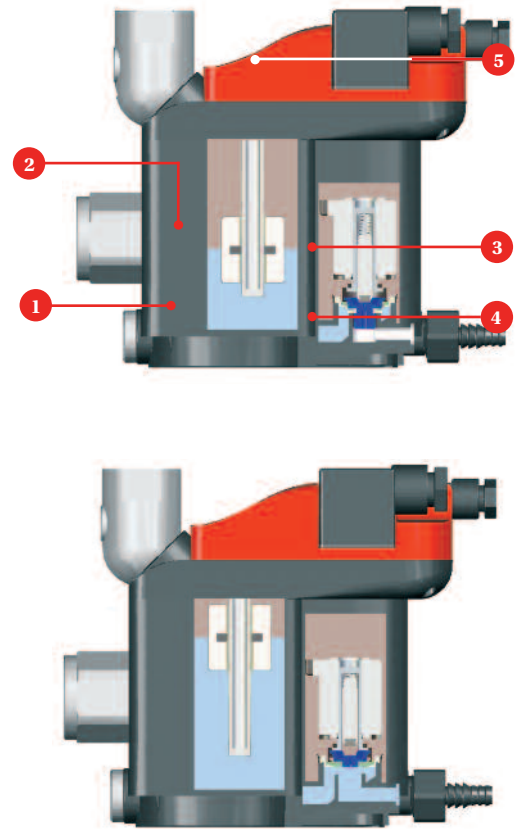

Time-controlled condensate drains waste energy and money

If the control of a condensate drain is not level controlled but exclusively time-based, it employs preset values for valve operating times and intervals. However, since the amount of condensate in a compressed air system changes constantly (e.g. summer/winter, maximum/part load), the following problems arise with time-controlled condensate drains:

- Valve operating time is set too short, or operating intervals are too long: Not enough condensate is drained. COMPRESSED AIR SYSTEM BACKS UP.
- Valve operating time is set too long, or operating intervals are too short: The valve remains open although all the condensate has been drained. COMPRESSED AIR ESCAPES.
- High switching frequency because the condensate collection tank is too small: Premature failure without possibility of servicing. COMPRESSED AIR SYSTEM BACKS UP.
- Small valve nozzles are very susceptible to contaminations: Valve can no longer close – COMPRESSED AIR ESCAPES CONTINUOUSLY.

Basis of the calculation:

- Valve aperture cross-section: \varnothing 3 mm
- Resulting flow rate at 8 bar: 600 litres/min
- Equivalent compressor power: 4.4 kW
- Energy costs: 0.07 €/kWh

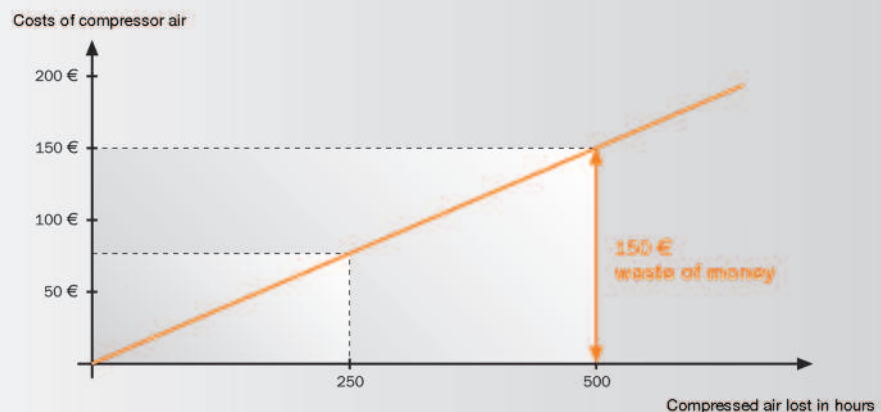

Dimensioning Electronic Condensate Drains

When dimensioning condensate drains, it must be taken into account that different quantities of condensate need to be drained from the aftercoolers (the condensate is drained from the aftercooler itself, a cyclone separator located downstream, or the pressure vessel), the refrigeration dryers (condensate is usually drained within the dryer itself) and from the filters (residual oil contents or small quantities of condensate).

1. Standard dimensioning

Standard dimensioning is based on the following reference conditions:

Ambient (suction) air compressor: 25°C and 60% relative humidity
 Working pressure: 7 bar
 Air discharge temperature aftercooler: 35°C
 Pressure dew-point refrigeration dryer: 3°C

The volume capacities stated in the technical specifications for the aftercooler, refrigeration dryer and the filter were calculated with these conditions.

Example:

Compressor(s) with 2,000 m³/h (1 bar(a), 20°C), operated under the above reference conditions

Drain aftercooler: ED3100 (1,800 - 6,000 m³/h) or ED2020 (1,290 - 6,000 m³/h)
 Drain refrigeration dryer: ED3030 (840 - 3,600 m³/h) or ED2010 (up to 2,580 m³/h)
 Drain filter: ED3004 (720 - 2,400 m³/h) or ED2010 (up to 12,900 m³/h)

2. Extended dimensioning

This extended method allows the dimensioning to be adapted to climatic conditions and operating pressures that vary from the reference conditions.

Working pressure	Ambient/Suction conditions (average summer temperature/relative humidity)									
	Compressor/Aftercooler					Refrigeration dryer				
	15°C 40%	20°C 50%	25°C 60%	30°C 70%	35°C 80%	15°C 40%	20°C 50%	25°C 60%	30°C 70%	35°C 80%
4 bar	16.5	3.4	1.5	0.8	0.5	2.6	1.8	1.3	1.0	0.7
6 bar	4.8	2.1	1.1	0.6	0.4	3.6	2.5	1.8	1.4	1.0
8 bar	3.4	1.7	0.9	0.6	0.4	4.7	3.3	2.4	1.8	1.3
10 bar	2.9	1.5	0.9	0.5	0.3	5.7	4.0	2.9	2.2	1.6
12 bar	2.6	1.4	0.8	0.5	0.3	6.8	4.7	3.4	2.6	1.9
14 bar	2.5	1.3	0.8	0.5	0.3	7.8	5.5	4.0	2.9	2.2
16 bar	2.4	1.3	0.8	0.5	0.3	8.9	6.2	4.5	3.3	2.5
25 bar	2.1	1.2	0.7	0.5	0.3	13.5	9.5	6.9	5.1	3.9
50 bar	1.9	1.1	0.7	0.4	0.3	26.6	18.6	13.5	10.0	7.6

All correction factors refer to the capacity of the drains on the aftercooler; they have been calculated for an aftercooler discharge temperature of +10°C above ambient/suction temperature and 3°C pressure dew-point of the refrigeration dryer.

Example:

Compressor(s) with 2,000 m³/h (1 bar(a), 20°C), operated at 10 bar working-pressure. The average day temperature in summer is 30°C with 70% relative humidity.

Correction factor aftercooler: 0.5 (see table)

Correction factor refrigeration dryer: 2.2 (see table)

Correction factor filter: always 10

Drain aftercooler: 2,000 m³/h ÷ 0.5 = 4,000 m³/h (referred to compressor/aftercooler capacity)

Drain refrigeration dryer: 2,000 m³/h ÷ 2.2 = 910 m³/h (referred to compressor/aftercooler capacity)

Drain filter: 2,000 m³/h ÷ 10 = 200 m³/h (referred to compressor/aftercooler capacity)

Drain aftercooler: ED3100 (1,800 - 6,000 m³/h) or ED2020 (1,290 - 6,000 m³/h)

Drain refrigeration dryer: ED3030 (420 - 1,800 m³/h) or ED2010 (up to 1,290 m³/h)

Drain filter: ED3004 (up to 240 m³/h) or ED2010 (up to 1,290 m³/h)

Parker Worldwide

Europe, Middle East, Africa

AE – United Arab Emirates,
Dubai

Tel: +971 4 8127100
parker.me@parker.com

AT – Austria, Wiener Neustadt

Tel: +43 (0)2622 23501-0
parker.austria@parker.com

AT – Eastern Europe, Wiener
Neustadt

Tel: +43 (0)2622 23501 900
parker.easteurope@parker.com

AZ – Azerbaijan, Baku

Tel: +994 50 2233 458
parker.azerbaijan@parker.com

BE/LU – Belgium, Nivelles

Tel: +32 (0)67 280 900
parker.belgium@parker.com

BY – Belarus, Minsk

Tel: +375 17 209 9399
parker.belarus@parker.com

CH – Switzerland, Etoy

Tel: +41 (0)21 821 87 00
parker.switzerland@parker.com

CZ – Czech Republic, Klecany

Tel: +420 284 083 111
parker.czechrepublic@parker.com

DE – Germany, Kaarst

Tel: +49 (0)2131 4016 0
parker.germany@parker.com

DK – Denmark, Ballerup

Tel: +45 43 56 04 00
parker.denmark@parker.com

ES – Spain, Madrid

Tel: +34 902 330 001
parker.spain@parker.com

FI – Finland, Vantaa

Tel: +358 (0)20 753 2500
parker.finland@parker.com

FR – France, Contamine s/Arve

Tel: +33 (0)4 50 25 80 25
parker.france@parker.com

GR – Greece, Athens

Tel: +30 210 933 6450
parker.greece@parker.com

HU – Hungary, Budapest

Tel: +36 1 220 4155
parker.hungary@parker.com

IE – Ireland, Dublin

Tel: +353 (0)1 466 6370
parker.ireland@parker.com

IT – Italy, Corsico (MI)

Tel: +39 02 45 19 21
parker.italy@parker.com

KZ – Kazakhstan, Almaty

Tel: +7 7272 505 800
parker.easteurope@parker.com

NL – The Netherlands, Oldenzaal

Tel: +31 (0)541 585 000
parker.nl@parker.com

NO – Norway, Asker

Tel: +47 66 75 34 00
parker.norway@parker.com

PL – Poland, Warsaw

Tel: +48 (0)22 573 24 00
parker.poland@parker.com

PT – Portugal, Leca da Palmeira

Tel: +351 22 999 7360
parker.portugal@parker.com

RO – Romania, Bucharest

Tel: +40 21 252 1382
parker.romania@parker.com

RU – Russia, Moscow

Tel: +7 495 645-2156
parker.russia@parker.com

SE – Sweden, Spånga

Tel: +46 (0)8 59 79 50 00
parker.sweden@parker.com

SK – Slovakia, Banská Bystrica

Tel: +421 484 162 252
parker.slovakia@parker.com

SL – Slovenia, Novo Mesto

Tel: +386 7 337 6650
parker.slovenia@parker.com

TR – Turkey, Istanbul

Tel: +90 216 4997081
parker.turkey@parker.com

UA – Ukraine, Kiev

Tel: +380 44 494 2731
parker.ukraine@parker.com

UK – United Kingdom, Warwick

Tel: +44 (0)1926 317 878
parker.uk@parker.com

ZA – South Africa, Kempton Park

Tel: +27 (0)11 961 0700
parker.southafrica@parker.com

North America

CA – Canada, Milton, Ontario

Tel: +1 905 693 3000

US – USA, Cleveland

Tel: +1 216 896 3000

Asia Pacific

AU – Australia, Castle Hill

Tel: +61 (0)2-9634 7777

CN – China, Shanghai

Tel: +86 21 2899 5000

HK – Hong Kong

Tel: +852 2428 8008

IN – India, Mumbai

Tel: +91 22 6513 7081-85

JP – Japan, Tokyo

Tel: +81 (0)3 6408 3901

KR – South Korea, Seoul

Tel: +82 2 559 0400

MY – Malaysia, Shah Alam

Tel: +60 3 7849 0800

NZ – New Zealand, Mt Wellington

Tel: +64 9 574 1744

SG – Singapore

Tel: +65 6887 6300

TH – Thailand, Bangkok

Tel: +662 186 7000-99

TW – Taiwan, Taipei

Tel: +886 2 2298 8987

South America

AR – Argentina, Buenos Aires

Tel: +54 3327 44 4129

BR – Brazil, Sao Jose dos Campos

Tel: +55 800 727 5374

CL – Chile, Santiago

Tel: +56 2 623 1216

MX – Mexico, Apodaca

Tel: +52 81 8156 6000

Ed.: 2011-03-03