

COMPRESSED AIR PURITY ANALYZER S600



ALL IN ONE
Dew point, particle and oil vapor



Smart measurement — save precious time



S600 FEATURES



ALL IN ONE
Dew point, particle and oil vapor



PRECISION
Accurate measurements



TOUCH SCREEN
Easy operation

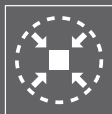

COMPACT DESIGN
Makes it unique



PORTABLE
Can be carried with one hand



USB INTERFACE
For data transfer

S600 BENEFITS

- All-in-one device measures Particle concentration, dew point and oil vapor
- Measures additionally the temperature and pressure
- Software guided measurement makes it easy to generate reliable results
- Report generator creates PDFs for audits
- Ultra portable and compact design
- Compressed air connection via 6 mm tube
- Integrated data logger saves data for later analysis
- Dew point measurement from -100... +20°C Td
- Oil vapor measurement from 0.003... 10.000 mg/m³
- Particle measurement from 0.1 < d ≤ 5.0 μm

ISO 8573 compliant purity quantifications of compressed air systems are bound to time-consuming installations and long-lasting test runs ... It's time for a revolution: The S600 is unlike its competition.

It combines the latest sensor technology, software-guided measurements and a time-saving setup into a handy, touch-screen controlled multi-tool. With our S600 you will finish measurement runs in much less time than with your traditional method, after that you don't ever want to leave your new comfort zone again. Trust us.

S600 DIMENSIONS

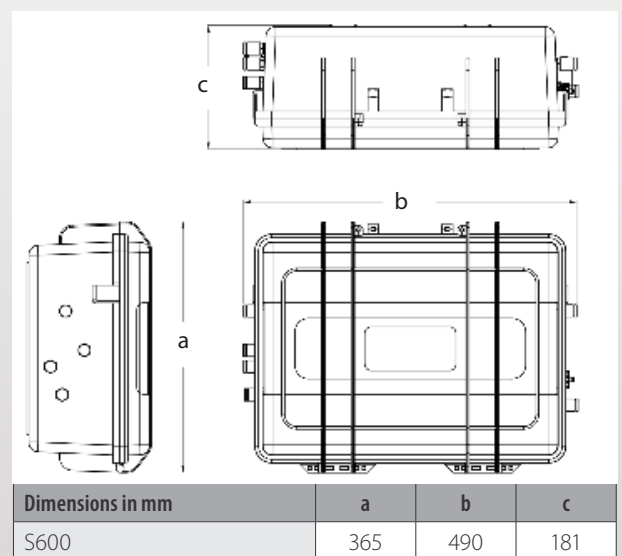

S600 APPLICATIONS

The S600 is the portable multi-tool for compressed air purity measurements. It measures, records and validates quality parameters like particles, dew point, oil vapor contents, temperature and the pressure of compressed air systems.

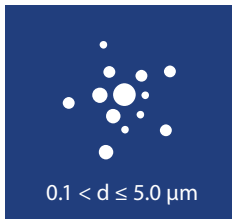

PARTICLE CONCENTRATION MEASUREMENT

- + Measurement methods according to ISO 8573 standards (together with isokinetic sampling device)
- + Latest laser detection technology
- + Smallest particle size 50% per JIS, bigger sizes 100% per JIS

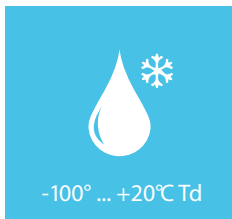

DEW POINT MEASUREMENT

- + Large ranges thanks to the unique multiple sensor technology
- + Long-term stable and well-proven measurement methods
- + High precision with an accuracy of $\pm 2^\circ\text{C Td}$

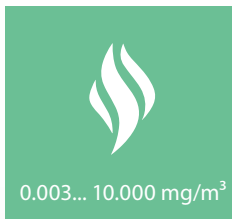

OIL VAPOR MEASUREMENT

- + Latest photoionisation detector (PID) with self-calibration
- + Wide range of oil vapor concentrations
- + High precision with 5% of reading $\pm 0.003 \text{ mg/m}^3$ accuracy

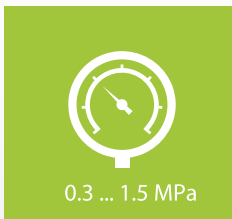

PRESSURE MEASUREMENT

- + State of the art sensor technology
- + Additional quality data about the compressed air system

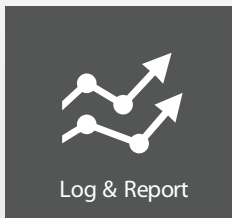

PLUG & PLAY MEASUREMENTS WITH A TOUCH

- + Integrated data logger records all channels in parallel for later analysis
- + 5" touchscreen allows you to interact with the device on site. There is no need for a PC to manage the device.

For particle measurements according to ISO 8573 an isokinetic sampling tube has been designed. This optional equipment enables you to monitor and adjust the air flow of the particle measurement to ensure the correct isokinetic sampling.

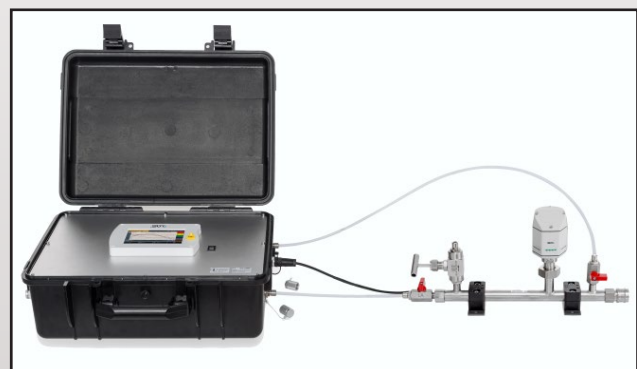

S600 with the isokinetic sampler attached

S600 TECHNICAL DATA

General Specifications			
Measuring unit	5"color touchscreen with data logger (100 mio. values), guided measurement and report generator function. All combined and integrated with the multiple sensor system.		
Medium humidity	< 40% relative humidity, no condensation		
Medium temperature	0 ... +40°C		
Operating pressure	0.3 ... 1.5 MPa		
Ambient & Transport conditions	0 ... +50°C / -10 ... +70°C		
Process connection	6 mm quick connect		
Power supply	Adapter: 100 ... 240 VAC, 50/60 Hz, 1.4 A		
Casing & Weight	PC, Al alloy, total product weight < 10 kg		
S600 - Measurement specs	Sensor type	Range	Accuracy
Particles	Laser optical detection	0.1 < d ≤ 0.5 µm 0.5 < d ≤ 1.0 µm 1.0 < d ≤ 5.0 µm	50 % @ 0.1 < d ≤ 0.15 µm 100% @ 0.15 µm < d per JIS
Oil vapor	Photoionisation detector PID	0.003 ... 10.000 mg/m ³	5% of value ± 0.003 mg/m ³
Dew point	Dual-sensor technology (QCM + Polymer)	-100 ... +20°C Td	±2°C Td

S600 ORDERING

Please use the following table to assist in placing your order with our sales staff.



Visit our website or e-mail us:
www.suto-itec.com
sales@suto-itec.com

S600 Portable Compressed Air Purity Analyzer	
Order No.	Description
P560 0600	<p>S600 Portable compressed air analyzer</p> <p>Touch screen interface, data logger, guided measurement, PDF report generator</p> <p>Particle: 0.1 < d ≤ 0.5 µm, 0.5 < d ≤ 1.0 µm, 1.0 < d ≤ 5.0 µm</p> <p>Dew point: -100 ... +20°C Td</p> <p>Oil vapor: 0.003 ... 10.000 mg/m³</p> <p>Including:</p> <ul style="list-style-type: none"> - S600 portable compressed air analyzer in a hand carry case with handle and shoulder belt - USB OTG memory stick - Operation and instruction manual - Certificate of calibration - Purge filter for pre-measurement (test kit) - 5 pcs. 6mm Teflon hose adapter, stainless steel - Power supply, 230 VAC / 24 VDC - 2 m Teflon hose, 6 OD x 4 ID mm, free adjustable - 1.5 m Teflon hose with quick connector
A554 0600	<p>Isokinetic sampling device for particle measurement according to ISO 8573</p> <p>Including:</p> <ul style="list-style-type: none"> - Isokinetic sampling pipe - Flow sensor mounted on pipe - Connection cable for S600